



Business Yukon TV Getting Started Guide

Updated February 2022

TABLE OF CONTENTS

INTRODUCTION TO BUSINESS YUKON TV

- 3 Is Yukon TV Right for My Business?
- 3 What is Needed to Operate Business Yukon TV?
- 3 How do I Switch?
- 4 Streaming Devices
- 4 Concurrency Limitations

STREAMING DEVICE SELECTION

- 8 Compare Streaming Devices

YUKON TV ON EVO PRO

- 10 Pre-Installation Checklist
- 11 Installation and Setup
- 12 EVO PRO Remote Control Guide
- 13 Using the Yukon TV App
 -Accessing and Navigating the Menu Bar
 -Operating the Channel Guide
 -Changing Channels
 -Turning on Closed Captions

YUKON TV ON AMAZON FIRE TV CUBE (OR FIRESTICK)

- 16 Pre-Installation Checklist
- 17 Installation and Setup
- 18 Alexa Remote Control Guide
- 23 Using the Yukon TV App

YUKON TV ON APPLE TV

- 20 Pre-Installation Checklist
- 21 Installation and Setup
- 22 Apple TV Remote Control Guide
- 23 Using the Yukon TV App
 -Accessing and Navigating the Menu Bar
 -Operating the Channel Guide
 -Changing Channels
 -Turning on Closed Captions

INTRODUCTION TO BUSINESS YUKON TV

IS YUKON TV RIGHT FOR MY BUSINESS?

Yukon TV is GCI's new TV streaming service that delivers your news, shows, and movies over a GCI internet connection. Business Yukon TV lets you watch live TV on up to 10 screens and continues to offer many of the features of GCI's legacy business TV service — though there are a few key differences:

Business Yukon TV:

- Is a streaming application, like Netflix, Hulu, and others
- Doesn't use a cable box; it uses a streaming device
- Is delivered over a GCI Business Internet connection (streaming does not count toward usage)
- Delivers all content in high definition (HD)
- Will time out after 4 hours of inactivity (simply interact to continue streaming)
- Certain channels are limited to as few as 3 concurrent screens (see chart on next page)
- Each screen requires login using your business account's MyGCI credentials

WHAT IS NEEDED TO OPERATE BUSINESS YUKON TV?

1. Business Yukon TV service
2. An active MyGCI account for your business
 - a. Your GCI business account username and password will serve as Yukon TV login credentials on all screens.
3. GCI Business Internet
 - a. Yukon TV requires a connection to GCI's core network, the data source behind Yukon TV service. Unlike other streaming apps, streaming Business Yukon TV does not count against your business internet plan's included high-speed data.
 - b. You may hardline your streaming device to a cable modem or connect to WiFi. NOTE: On WiFi connections, streaming devices perform best when placed near the router.
4. Streaming devices
 - a. You'll need one streaming device per television used to stream Business Yukon TV. Streaming devices can be mixed and matched across televisions.
5. The Yukon TV app, downloaded to each streaming device

HOW DO I SWITCH?

1. Contact your account rep to initiate the move to Business Yukon TV.
2. Obtain your desired streaming device(s).
3. Self-install using this guide, or schedule an installation appointment.
4. Return your legacy GCI TV equipment to a store or schedule a pickup within 15 days of service disconnect.

STREAMING DEVICES

Yukon TV is a streaming application that is supported on specific streaming devices. Compare the most popular streaming devices on page 8 to determine which one(s) will work best for your business's needs. For a complete list of Yukon TV-supported devices, visit www.gci.com/yukon-supported-devices.

Each screen that streams Yukon TV will need its own streaming device, and you can mix and match streaming devices from one screen to the next. Streaming devices can be purchased directly from GCI or from third-party sellers like Best Buy, Amazon, or Walmart. Devices range from under \$50 to \$180 apiece.

At this time, the Yukon TV app is not supported on smart TVs.

CONCURRENCY LIMITATIONS

Due to streaming rights, the following networks limit the number of concurrent streams available per account:

Channels	Channel Number	Concurrent Streams Limit
FX	32	3
FS1	41	3
National Geographic	54	3
Fox News	67	3
Nat GEO Wild	114	3
FXM	131	3
Fox Business	135	3
Smithsonian HD	235	3
FCS Atlantic - Fox College Sports	301	3
FCS Central - Fox College Sports	302	3
FCS Pacific - Fox College Sports	303	3
FS2	307	3
FXX	311	3
Big Ten Network	314	3
Lifetime	23	5
ESPN	34	5
ESPN 2	35	5
NFL Network	37	5
LMN	42	5
Animal Planet	47	5
Disney XD	48	5
Disney	49	5

Channels	Channel Number	Concurrent Streams Limit
Freeform	51	5
TLC	55	5
Discovery	56	5
Travel Channel	57	5
History Channel	58	5
A&E	59	5
HGTV	60	5
Food Network	61	5
Disney Jr	96	5
Discovery Family	101	5
OWN	102	5
Science Channel	103	5
American Heroes Channel	104	5
Destination America	105	5
Investigation Discovery	106	5
ESPNews	112	5
MGM HD	132	5
ESPNU	134	5
Cooking Channel	143	5
Discovery Life	144	5
SEC Network	150	5
ACC Network	151	5
FYI	203	5
Viceland	204	5
Crime & Investigation	205	5
DIY	206	5
Great American Country	207	5
Military History Channel	209	5
LRW	211	5
Eleven Sports	312	5
Motortrend	322	5
NFL RedZone	350	5
Paramount Network	38	6
TV Land	45	6
Nickelodeon	50	6
CMT	75	6
MTV	76	6
VH1	77	6

Channels	Channel Number	Concurrent Streams Limit
Comedy Central	81	6
BET	84	6
Nick Jr	107	6
Teenick	108	6
Nicktoons	109	6
MTV2	115	6
NickMusic	116	6
MTV Classic	117	6
CMT Music	136	6
BET Soul	137	6
Logo Network	139	6
BET Jams	140	6

STREAMING DEVICE SELECTION

COMPARE STREAMING DEVICES

You'll need one streaming device per television that you use to stream Yukon TV. Streaming devices can be mixed and matched across televisions. These devices look and act a lot like a cable box, complete with a remote control. Use the table below to decide which Yukon TV-supported streaming device is the best fit for you.

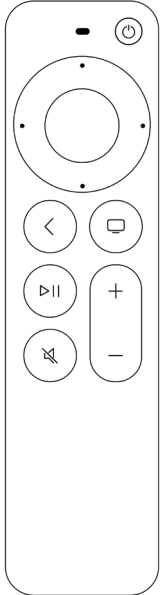
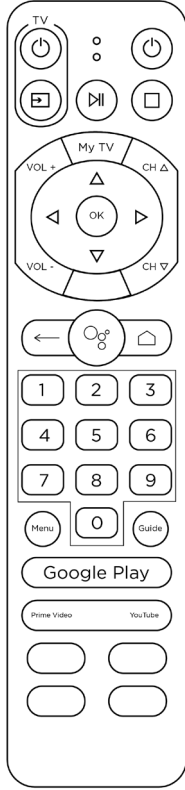
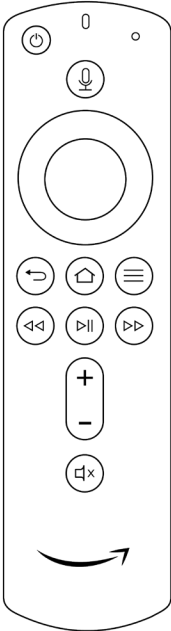
Device	Apple TV	EVO PRO	Amazon Fire TV Cube/Firestick
Best for...	Apple users and tech-savvy viewers who will use their streaming device to access multiple apps.	Traditional TV viewers who want as minimal change as possible to their television-watching experience. <i>*Device does not support Netflix.</i>	Android and Amazon smart home users who prefer Samsung products and will use their streaming device to access multiple apps.
App Store	Apple Store	Google Play Store	Amazon App Store
Remote - Navigational Design			

For a complete list of Yukon TV-supported devices, visit www.gci.com/yukon-supported-devices.

YUKON TV ON EVO PRO

PRE-INSTALLATION CHECKLIST

Before you get started, you'll need:

- Your business account's MyGCI profile username and password (for app sign in)
- An active Gmail account (for device log in)
- WiFi access on GCI Business Internet including network name and password

Already have these items ready to go? Skip to Installation on page 11.

Help with your business account's MyGCI profile username and password

1. Access the internet on a phone, tablet, or computer.
2. Type in the web address in the address bar:
 - a. Create a new account: **www.my.gci.com/register**
 - b. Forgotten username: **www.my.gci.com/retrieve-username**
 - c. Forgotten password: **www.my.gci.com/request-password-reset**
3. Follow the onscreen instructions.

Need additional assistance? Contact your GCI Account Manager or call 800-800-4800.

Help creating or accessing a Gmail account

1. Access the internet on a phone, tablet, or computer.
2. Type in the web address in the address bar:
 - a. Create a new account: **www.accounts.google.com/signup**
 - i. Follow the onscreen instructions.
 - b. Forgotten password: **www.accounts.google.com/signin**
 - i. Enter the email address associated with your chosen Google account and click *Next*.
 - ii. On the next screen, select *Forgot password?*
 - iii. Follow the onscreen instructions to reset the password.
 - c. Forgotten email address: **www.accounts.google.com**
 - i. Select *Forgot email?*
 - ii. Enter the phone number or recovery email address.

Help with WiFi access

For the best experience, we recommend using a GCI-provided WiFi modem.

Forgotten login information:

1. If you are using a GCI-provided modem and never changed your default login settings, your network name and password information is printed on your modem's label. When prompted, enter this information as your WiFi name and password.
2. If you are using a GCI-provided WiFi modem and *did* change your login settings, call us at 800-800-4800 to have your system reset to factory settings.



INSTALLATION

Connect your EVO PRO to your television

You'll need (all items included in EVO PRO box):

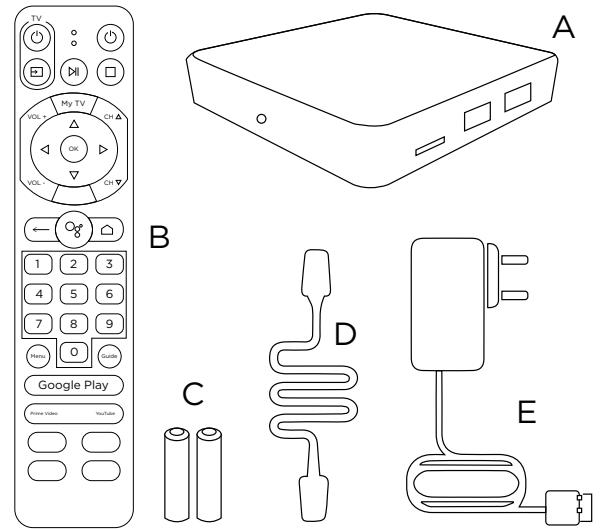
- EVO PRO (A)
- EVO PRO remote control (B)
- 2 AA batteries (C)
- HDMI cord (D)
- Power cord (E)



1. Using the **HDMI cord**, plug one end into your television, and the other end into your **EVO PRO** device.
2. Connect one end of the HDMI cable into the  port of the EVO PRO. Connect the other end into the  port on your TV.
 - a. Remember which  port was used for the device. You'll need that information later during setup.
3. Using the **power cord**, plug the circular end into the port labeled “DC 5V” on the **EVO PRO device**, and plug the other end into an electrical outlet.
4. Insert the **batteries** into your **EVO PRO remote**.
5. Turn on your TV.

SETUP

Connect your device to the internet

You will be asked to enter the network name and password of your GCI Business Internet WiFi connection. Follow the onscreen instructions to complete this step.

Sign into your Google account

You will be asked to sign into your Google-powered EVO PRO device by entering a Google email address and password. Follow the onscreen instructions to complete this step.

Device setup

You will be asked to enter some information to set up your EVO PRO device. Follow the onscreen instructions, which include:

1. Choose your TV brand:
 - a. Select your TV brand from the list of common brands on the left of the screen or use the *Search* bar to type in your TV brand.
2. Verify Smart RCU (pair your EVO PRO remote to your TV)
 - a. Follow the onscreen instructions to confirm that your television is responding to your remote control's commands.
 - b. When asked to confirm your TV input, be sure the correct HDMI port is selected.

Download Yukon TV

1. On first use, press the **My TV** button to be brought to the Yukon TV app download screen.
2. Click *Install*.
3. Click *Open*.



Troubleshooting tip: If the app does not download, press the Google Play button on your remote and manually type *Yukon TV* into the search bar. Select the Yukon TV app and click *Install*.

Sign into Yukon TV

1. Use your business account's MyGCI username and password to sign into Yukon TV.
2. After signing in, you'll be taken to the Yukon TV home screen.

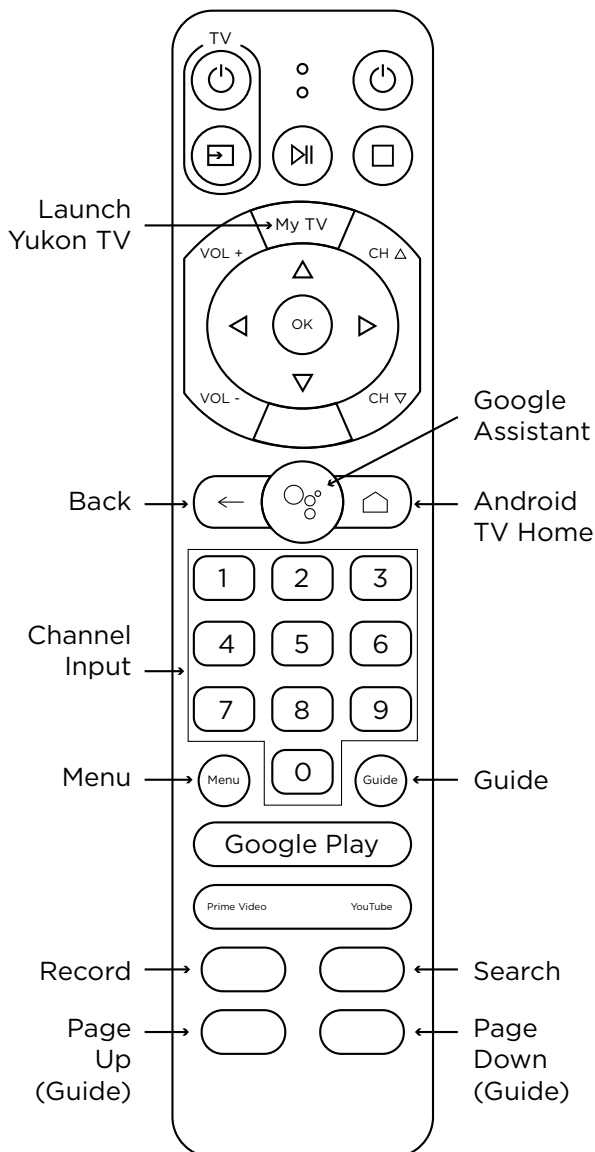

See *page 10* for help signing into MyGCI.



EVO PRO REMOTE CONTROL GUIDE

Remote control quick tips:

To quickly launch Yukon TV from any screen, press **My TV**.

The  button on your remote takes you to the EVO PRO home screen, where you can access all apps that have been downloaded to your EVO PRO device. To get back to the Yukon TV home screen, press **My TV**, then press the  button twice.

Access the Yukon TV menu bar from any screen by pressing the  button.

USING THE YUKON TV APP ON EVO PRO

Menu bar

Press the ← button to pull up the menu bar at the top of the screen, which allows you to perform several other actions:

Home - Takes you to the home screen where you can scroll through suggested content.

LiveTV - Resumes live TV on the last channel viewed.

Guide - Displays a list of channels and their scheduled programming.

Search - A tool to help you quickly find specific content.

 **Settings** - Go here to update your account information.

 **Profile** - Go here to switch between user profiles.



Channel guide



Using the guide

1. Press the ← button to pull up the menu bar at the top of the screen.
2. Click **Guide**.
3. To play a program, highlight it and press **OK**.

 **Remote control shortcut:** Press the  button on your remote to access the Guide.

Browsing the guide

- To scroll the Guide page by page: use the yellow  button on the bottom left of your remote to scroll page up, and the blue  button on the bottom right of your remote to scroll page down.
- To scroll the Guide by individual channel: use the  buttons on the directional pad.
- To go directly to a specific channel: key in the channel number and either wait 2 seconds, or press **OK**.



 **Remote control shortcut:** While watching TV, press the  buttons on the directional pad to bring up an in-screen guide on the left of your screen. Browse and press **OK** to change the channel.

Changing channels

Different ways to change the channel:

- Use the Δ/∇ buttons on the directional pad.
- Use the CH Δ /CH ∇ buttons.
- Use the **number buttons** to key in the channel number you wish to watch.
- Select a channel from the **Guide**.
- Press the green  **Search key** to find a specific channel or program.

Turning on closed captions (subtitles)

1. While watching a show, press the  button to bring up the playback menu.
2. On the right, select the  icon, press **OK**.
3. Choose your Audio settings.
4. Select *CLOSED CAPTIONS*, press **OK**.
5. Select *CLOSE*, press **OK**.

YUKON TV ON AMAZON FIRE TV CUBE (OR FIRESTICK)

PRE-INSTALLATION CHECKLIST

Before you get started, you'll need:

- Your business account's MyGCI profile username and password (for app sign in)
- An active Amazon account (for device log in)
- WiFi access on GCI Business Internet including network name and password

Already have these items ready to go? Skip to Installation on page 17.

Help with your business account's MyGCI profile username and password

1. Access the internet on a phone, tablet, or computer.
2. Type in the web address in the address bar.
 - a. Create a new account: **www.my.gci.com/register**
 - b. Forgotten username: **www.my.gci.com/retrieve-username**
 - c. Forgotten password: **www.my.gci.com/request-password-reset**
3. Follow the onscreen instructions.

Need additional assistance? Contact your GCI Account Manager or call 800-800-4800.

Help creating or accessing an Amazon account

1. Create a new account:
 - a. Open **www.amazon.com** on a phone, tablet, or computer.
 - b. Hover over *Hello, Sign in Account & Lists* then under *Sign in*, click ***New customer? Start here.***
 - c. Follow onscreen instructions.
 - i. Note that you will be required to enter payment information to complete setup. Your account is free, the Yukon TV app is free, and you will not be charged unless you make a purchase.
2. Forgotten password:
 - a. Open **www.amazon.com** on a phone, tablet, or computer.
 - b. Hover over *Hello, Sign in Account & Lists* then click ***Sign in.***
 - c. Click *Forgot your password?*
 - d. Enter your account's associated email or mobile phone number and follow onscreen instructions.

Help with WiFi access

For the best experience, we recommend using a GCI-provided WiFi modem.

Forgotten login information:

1. If you are using a GCI-provided modem and never changed your default login settings, your network name and password information is printed on your modem's label. When prompted, enter this information as your WiFi name and password.
2. If you are using a GCI-provided WiFi modem and *did* change your login settings, call us at 800-800-4800 to have your system reset to factory settings.





INSTALLATION

Connect your Fire TV Cube to your television

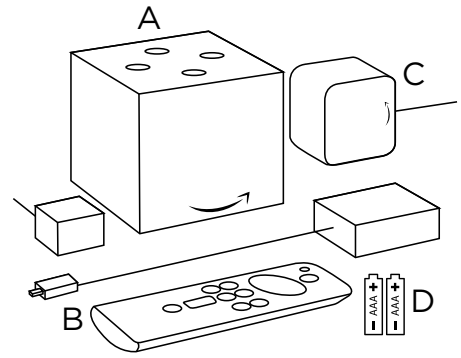
You'll need:

- Fire TV Cube (A)
- Alexa Voice Remote (B)
- Power cord (C)
- 2 AAA batteries (D)
- HDMI cable (not included)



1. Place your Fire TV Cube 1 to 2 ft. away from any speakers.
2. Connect one end of the HDMI cable (not included) into the  port of the Fire TV Cube. Connect the other end into the  port on your TV.
 - a. Remember which  port was used for the device. You'll need that information later during setup.
3. Plug the power cord into your Fire TV Cube and then into a power outlet.
4. Put batteries in your Alexa Voice remote.
5. Turn on your TV and switch to the correct HDMI input.
 - a. If your remote doesn't pair automatically, press the  button until "Press  to start" appears onscreen (about 10 seconds).

SETUP

Connect your device to the internet

Follow the onscreen instructions to connect to WiFi and download the latest software update.



Sign into an Amazon account

You will be asked to sign into your Amazon device by entering your Amazon login information. Follow the onscreen prompts to complete this step. You will need your mobile phone or computer to visit the onscreen web address (www.amazon.com/code) and enter the verification code.

Device setup

After signing into your Amazon account and entering the verification code, follow the onscreen instructions to set up equipment control for devices like soundbars.

Download Yukon TV

1. Click *Find* from the device's home screen menu.
2. Click *App Store*.
3. From the page menu, click *Search*.
4. Type in "Yukon TV" and search.
5. Select Yukon TV.
6. Click *Get*  or the *Shopping Cart*  icon to start your download.

Sign into Yukon TV

1. Use your business account's MyGCI username and password to sign into Yukon TV.
2. After signing in, you'll be taken to the Yukon TV Home screen.

See *page 16* for help signing into MyGCI.

USING THE YUKON TV APP ON AMAZON DEVICES

Jump to page 23.

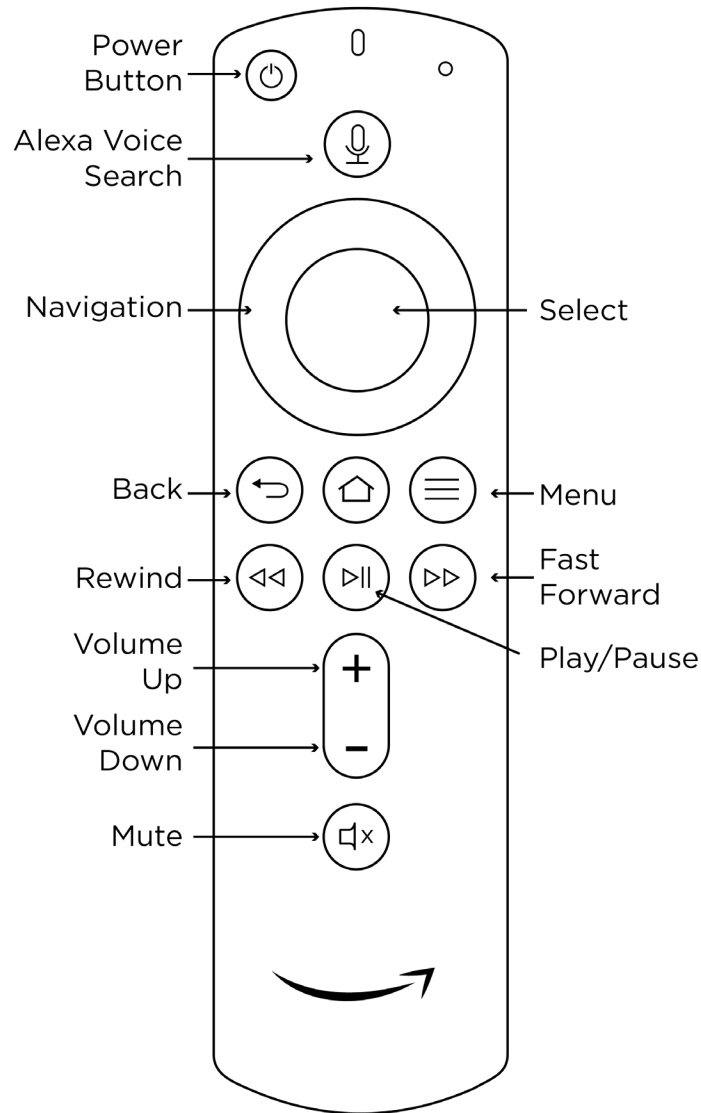

AMAZON REMOTE CONTROL GUIDE

Remote control quick tips:

Hold the  button to force quit the app.

While using the Yukon TV app, access the Yukon TV menu bar from any screen by pressing the  button.

The  button takes you to Amazon device's home screen, where you can access all apps that have been downloaded to device. To get back to Yukon TV, select the Yukon TV app from your device's app library.

YUKON TV ON APPLE TV

PRE-INSTALLATION CHECKLIST

Before you get started, you'll need:

- Your business account's MyGCI profile username and password (for app sign in)
- An active Apple ID (for device log in)
- WiFi access on GCI Business Internet including network name and password

Already have these items ready to go? Skip to Installation on page 21.

Help with your business account's MyGCI profile username and password

1. Access the internet on a phone, tablet, or computer.
2. Type in the web address in the address bar:
 - a. Create a new account: www.my.gci.com/register
 - b. Forgotten username: www.my.gci.com/retrieve-username
 - c. Forgotten password: www.my.gci.com/request-password-reset
3. Follow the onscreen instructions.

Need additional assistance? Contact your GCI Account Manager or call 800-800-4800.

Help creating or accessing an Apple ID

1. Create a new account:
 - a. When you set up an Apple TV and are asked for an Apple ID, click *"Forgot password or don't have an Apple ID?"*
 - b. Click *"Create a Free Apple ID."*
 - c. Follow onscreen instructions.
 - i. Note that you will be required to enter payment information to complete setup. Your account is free, the Yukon TV app is free, and you will not be charged unless you make a purchase.
2. Forgotten password:
 - a. When you set up an Apple TV and are asked for your Apple ID, click *"Forgot password or don't have an Apple ID?"*
 - b. Click *"Forgot password."*
 - c. Follow the onscreen instructions.

Help with WiFi access

For the best experience, we recommend using a GCI-provided WiFi modem.

Forgotten login information:

1. If you are using a GCI-provided modem and never changed your default login settings, your network name and password information is printed on your modem's label. When prompted, enter this information as your WiFi name and password.
2. If you are using a GCI-provided WiFi modem and *did* change your login settings, call us at 800-800-4800 to have your system reset to factory settings.



INSTALLATION

How to connect your Apple TV to your television

You'll need:

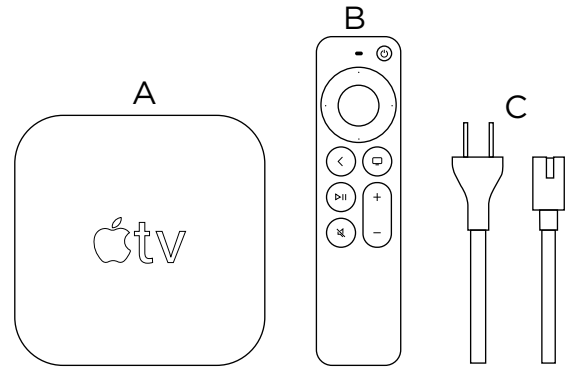
- Apple TV (A)
- Apple TV remote (B)
- Power cord (C)
- HDMI cable (not included)



1. Connect one end of the HDMI cable (not included) into the  port of your Apple TV. Connect the other end into the  port on your TV.
 - a. Remember which  port was used for the device. You'll need that information later during setup.
2. Plug the power cord into your Apple TV and then into a power outlet.
3. Turn on your TV and switch to the correct HDMI input.

SETUP

WiFi access and Apple ID login

Popular choice: If you don't want to set up your Apple TV with your iPhone or iPad, choose **Set Up Manually**. Then follow the onscreen steps on your Apple TV to connect to your WiFi network and sign in with your Apple ID.

To use your iPhone or iPad to automatically add your personal Apple ID and WiFi settings to your Apple TV, choose **Set Up with Device**. Then unlock your iPhone or iPad, hold it next to your Apple TV, and follow the onscreen steps on your handheld device and Apple TV.

Device setup

After signing in with an Apple ID, follow the onscreen instructions to set up equipment.

Download Yukon TV

1. Select the App Store app from your app library.
2. Search "Yukon TV."
3. Click *Get*.

Sign into Yukon TV

1. Use your business account's MyGCI username and password to sign into Yukon TV.
2. After signing in, you'll be taken to the Yukon TV Home screen.

See *page 20* for help signing into MyGCI.

APPLE TV REMOTE CONTROL GUIDE

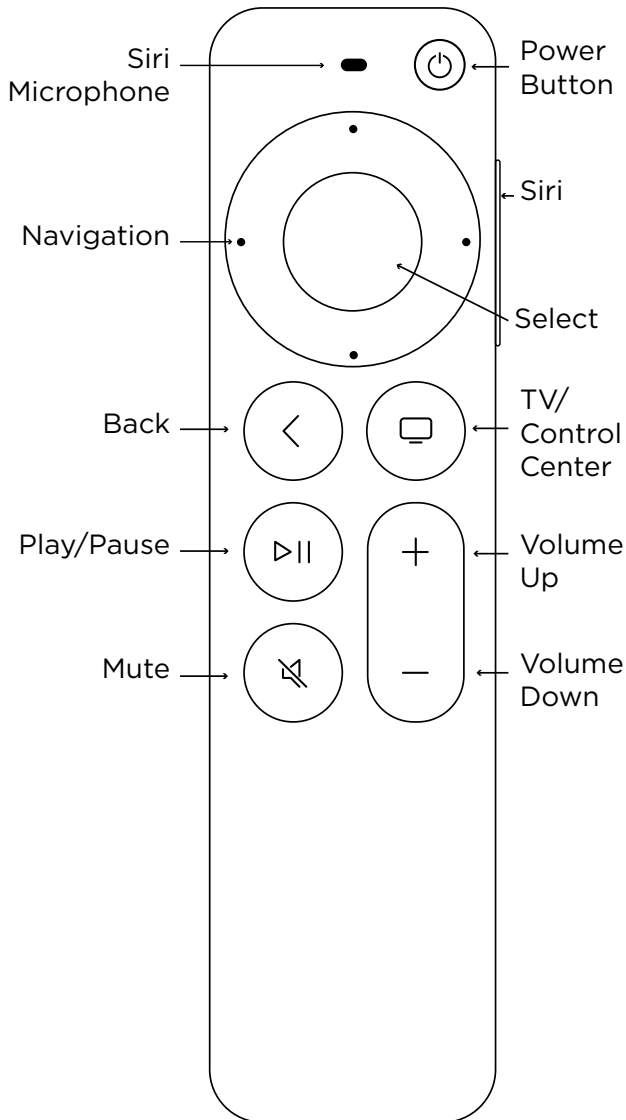

Remote control quick tips:





Double tap the  button to force quit the app.



While using the Yukon TV app, access the Yukon TV menu bar from any screen by pressing the  button (depending on your Apple TV model).

The  button on your remote takes you to the Apple TV home screen, where you can access all apps that have been downloaded to your streaming device. To get back to Yukon TV, select the Yukon TV app.

USING THE YUKON TV APP ON AMAZON AND APPLE TV DEVICES





Menu bar

Press the / or / button to pull up the menu bar at the top of the screen, which allows you to perform several other actions:



- Home** - Takes you to the home screen where you can scroll through suggested content.
- LiveTV** - Resumes live TV on the last channel viewed.
- Guide** - Displays a list of channels and their scheduled programming.
- Search** - A tool to help you quickly find specific content.
-  **Settings** - Go here to update your account information.
-  **Profile** - Go here to switch between user profiles.





Channel guide

Using the guide

1. Press / or / to open the top menu bar.
2. Click **Guide**.
3. To play a program, highlight it and press the  button.

Browsing the guide

You can scroll the guide by individual channel by using the / buttons on the directional pad. Long-press to scroll quickly; tap to scroll one channel at a time.





 **Remote control shortcut:** While watching TV, press the / buttons on the directional pad, or tap your trackpad to bring up an in-screen guide on the left of your screen. Browse and press the  button to change the channel.

Changing channels

Different ways to change the channel:

1. Use the  button on the directional pad.
2. Select a channel from the **Guide**.

Turning on closed captions (subtitles)

1. While watching a show, press the  button to bring up the playback menu.
2. On the right, select the  icon, press the  button.
3. Choose your Audio settings.
4. Select **CLOSED CAPTIONS**, press the  button.
5. Select **CLOSE**, press the  button.